

SANYO	No.485F	2SC2314
		NPN Epitaxial Planar Silicon Transistor
27MHz CB Transceiver Driver Applications		

Absolute Maximum Ratings at Ta = 25°C

				unit
Collector-to-Base Voltage	V _{CB0}	R _{BE} = 150Ω	75	V
Collector-to-Emitter Voltage	V _{CER}		75	V
Collector-to-Emitter Voltage	V _{CEO}		45	V
Emitter-to-Base Voltage	V _{EBO}		5	V
Collector Current	I _C		1.0	A
	I _{CP}		1.5	A
Collector Dissipation	P _C		750	mW
		T _c = 25°C	5	W
Junction Temperature	T _j		150	°C
Storage Temperature	T _{stg}		-55 to +150	°C

Electrical Characteristics at Ta = 25°C

			min	typ	max	unit
Collector Cutoff Current	I _{CBO}	V _{CB} = 40V, I _E = 0			1.0	μA
Emitter Cutoff Current	I _{EBO}	V _{EB} = 4V, I _C = 0			1.0	μA
C-B Breakdown Voltage	V _{(BR)CBO}	I _C = 10μA, I _E = 0	75			V
C-E Breakdown Voltage	V _{(BR)CER}	I _C = 1mA, R _{BE} = 150Ω	75			V
C-E Breakdown Voltage	V _{(BR)CEO}	I _C = 1mA, R _{BE} = ∞	45			V
E-B Breakdown Voltage	V _{(BR)EBO}	I _E = 10μA, I _C = 0	5			V
DC Current Gain	h _{FE}	V _{CE} = 5V, I _C = 500mA	60※		320※	
Gain-Bandwidth Product	f _T	V _{CE} = 10V, I _C = 50mA	180	250		MHz
Output Capacitance	C _{ob}	V _{CB} = 10V, f = 1MHz		15	25	pF
Output Power	P _o	V _{CC} = 12V, f = 27MHz, P _i = 35mW	1.0	1.8		W
Collector Efficiency	η _c	See specified Test Circuit.	60			%
C-E Saturation Voltage	V _{CE(sat)}	I _C = 500mA, I _B = 50mA		0.2	0.6	V
B-E Saturation Voltage	V _{BE(sat)}	I _C = 500mA, I _B = 50mA		0.9	1.2	V

※ : The 2SC2314 is classified by 500mA h_{FE} as follows :

60 D 120	100 E 200	160 F 320
----------	-----------	-----------

Collector Efficiency Test Circuit

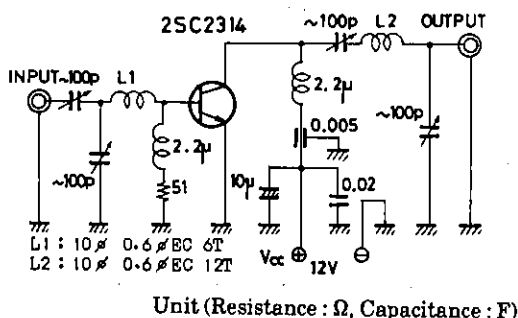

Package Dimensions 2009A

(unit : mm)

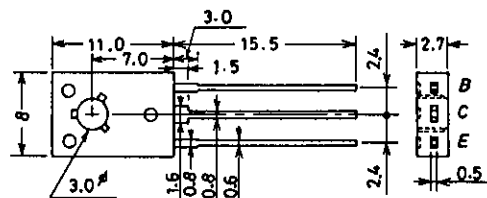

JEDEC: TO-126

B: Base
C: Collector
E: Emitter

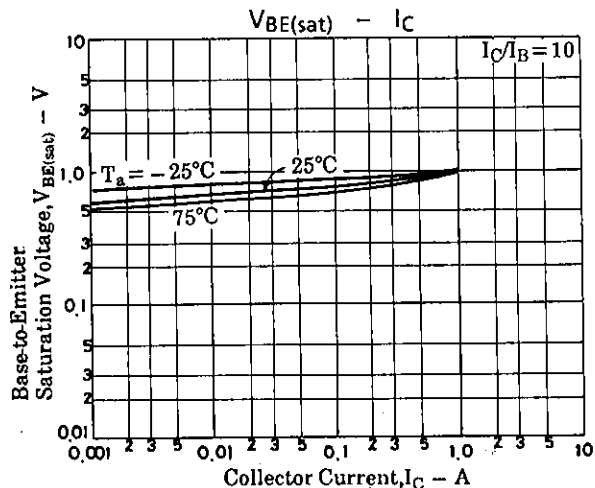
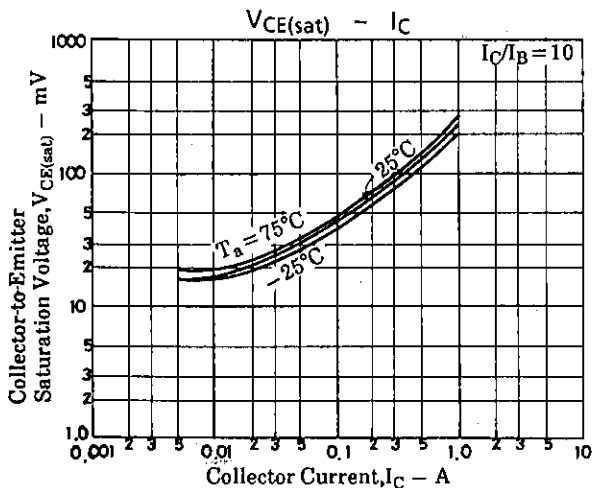
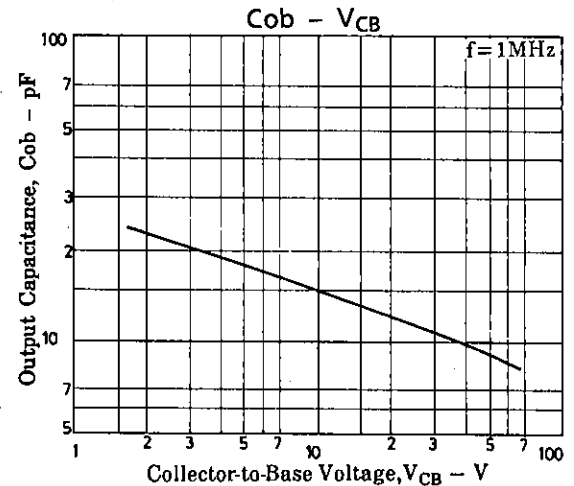
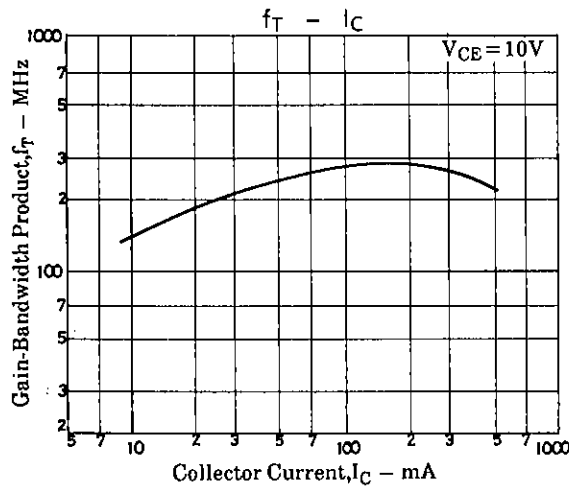
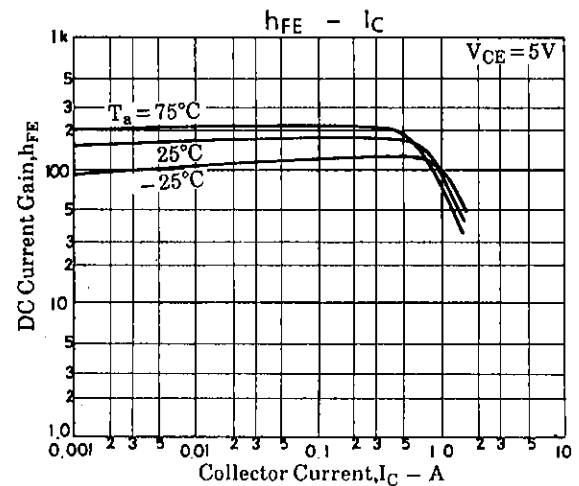
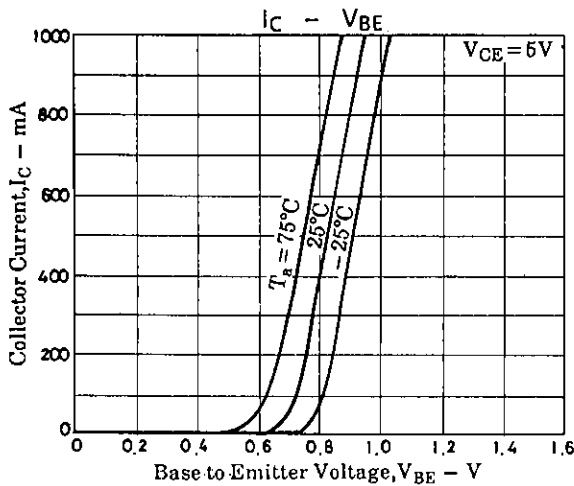
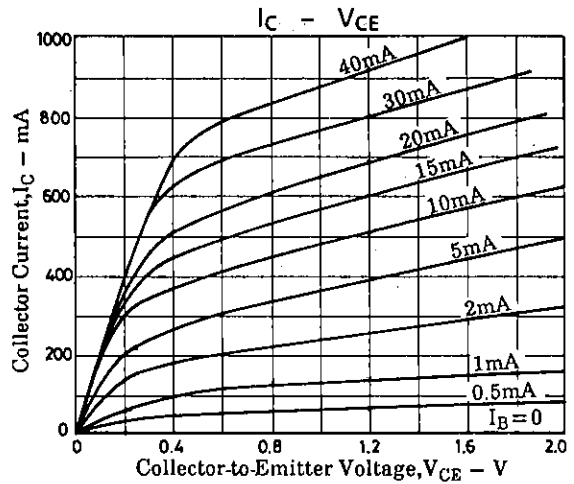
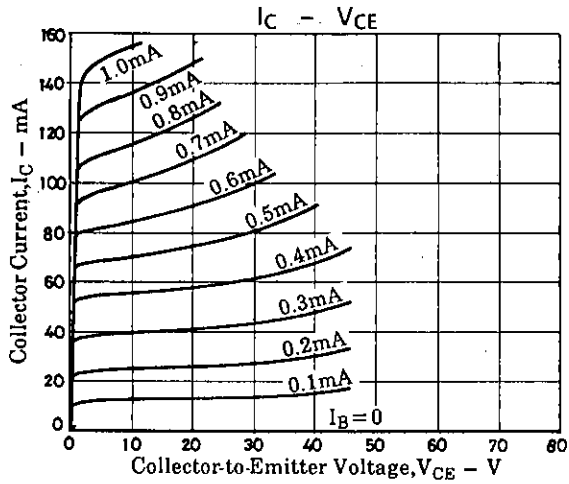

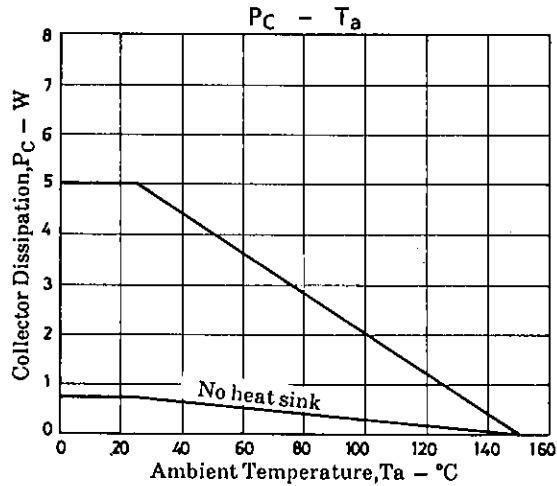

- No products described or contained herein are intended for use in surgical implants, life-support systems, aerospace equipment, nuclear power control systems, vehicles, disaster/crime-prevention equipment and the like, the failure of which may directly or indirectly cause injury, death or property loss.
- Anyone purchasing any products described or contained herein for an above-mentioned use shall:
 - ① Accept full responsibility and indemnify and defend SANYO ELECTRIC CO., LTD., its affiliates, subsidiaries and distributors and all their officers and employees, jointly and severally, against any and all claims and litigation and all damages, cost and expenses associated with such use:
 - ② Not impose any responsibility for any fault or negligence which may be cited in any such claim or litigation on SANYO ELECTRIC CO., LTD., its affiliates, subsidiaries and distributors or any of their officers and employees jointly or severally.
- Information (including circuit diagrams and circuit parameters) herein is for example only; it is not guaranteed for volume production. SANYO believes information herein is accurate and reliable, but no guarantees are made or implied regarding its use or any infringements of intellectual property rights or other rights of third parties.